

Differential Pressure Sensor Air

Differential pressure transmitter with 8 selectable ranges and outputs 0...5 V, 0...10 V or 4...20 mA. For monitoring the differential pressure of air and other non-flammable and non-aggressive gases. Monitoring air filters, fans, industrial cooling air cycles, control of air and fire dampers. Options available with LCD display, auto-zero feature. IP65 / NEMA 4X rated enclosure.

Type Overview

Type	Measuring range pressure	Output signal active pressure	Burst pressure	Display type	Additional features
22ADP-18Q	0...250 Pa	DC 0...10 V, DC 0...5 V, 4...20 mA	40 kPa	-	-
22ADP-18QA	0...250 Pa	DC 0...10 V, DC 0...5 V, 4...20 mA	40 kPa	-	Auto-Zero
22ADP-18QB	0...250 Pa	DC 0...10 V, DC 0...5 V, 4...20 mA	40 kPa	LCD	Auto-Zero
22ADP-18QL	0...250 Pa	DC 0...10 V, 4...20 mA, DC 0...5 V	40 kPa	LCD	-

Technical Data

Electrical data	Power supply DC	15...24 V, $\pm 10\%$, 1.1 W
	Power supply AC	24 V, , $\pm 10\%$, 1.7 VA
	Electrical connection	Removable spring loaded terminal block max. 2.5 mm ²
Functional data	Cable entry	Cable gland with strain relief $\varnothing 6...8$ mm
	Sensor Technology	Piezo measuring element
	Multirange	8 measuring ranges selectable
	Output signal active note	Output DC 0...5/10 V selectable with switch Voltage output: min. 10 k Ω load Current output: max. 500 Ω load
	Display	LCD, 29x35 mm with backlight Measured values: Pa, inchWC (configurable)
	Application	Air
	Response time	Adjustable 0.8s or 4.0s

Measuring data	Measuring values	Differential pressure			
	Measuring fluid	Air and non-aggressive gases			
	Measuring range settings pressure	Setting	range [Pa]	range [inch WC]	Factory setting
		S0	0...250	0...1	✓
		S1	0...100	0...0.4	
		S2	0...50	0...0.2	
		S3	0...25	0...0.1	
		S4	-25...25	-0.1...0.1	
		S5	-50...50	-0.2...0.2	
		S6	-100...100	-0.4...0.4	
	S7	-150...150	-0.6...0.6		
	Accuracy pressure	deviation compared to the reference device ±1 Pa at range <250 Pa			
Materials	Cable gland	PA6, black			
	Housing	Cover: Lexan, orange Bottom: Lexan, orange Seal: 0467 NBR70, black UV resistant			
Safety data	Ambient humidity	Max. 95% r.H., non-condensing			
	Ambient temperature	-10...50°C [15...120°F]			
	Fluid temperature	-10...50°C [15...120°F]			
	Protection class IEC/EN	III Safety Extra-Low Voltage (SELV)			
	Protection class UL	UL Class 2 Supply			
	EU Conformity	CE Marking			
	Certification IEC/EN	IEC/EN 60730-1 and IEC/EN 60730-2-6			
	Certification UL	cULus acc. to UL60730-1A/-2-6, CAN/CSA E60730-1:02			
	Degree of protection IEC/EN	IP65			
	Degree of protection NEMA/UL	NEMA 4X			
Quality Standard	ISO 9001				

Safety notes

This device has been designed for use in stationary heating, ventilation and air-conditioning systems and must not be used outside the specified field of application. Unauthorised modifications are prohibited. The product must not be used in relation with any equipment that in case of a failure may threaten humans, animals or assets.

Ensure all power is disconnected before installing. Do not connect to live/operating equipment.

Only authorised specialists may carry out installation. All applicable legal or institutional installation regulations must be complied during installation.

The device contains electrical and electronic components and must not be disposed of as household refuse. All locally valid regulations and requirements must be observed.

Remarks
Automated Zero-Point calibration (Auto-Zero)

Transmitters equipped with the auto-zero calibration are maintenance-free.

The auto-zero calibration electronically adjusts the transmitter zero every 10 minutes. The function eliminates all output signal drift due to thermal, electronic or mechanical effects. The auto-zero adjustment takes approx. 4 seconds after which the device returns to its normal measuring mode. During the 4 second adjustment period, the output and display values will freeze to the latest measured value.

Manual Zero-Point calibration

In normal operation zero-point calibration should be executed every 12 months.

Attention! For executing zero-point calibration the power supply must be connected one hour before.

- Release both connection tubes from the pressure terminals + and -
- Press the button until the LED lights permanently
- Wait until the LED flashes again and reinstall the connection tubes to the pressure ports (note + and -)

Scope of delivery

Scope of delivery	Description	Type
	Mounting plate L housing	A-22D-A10
	Duct connector kit, PVC tube 2 m, 2 connection elements (Plastic) for 22ADP-..	A-22AP-A08
	Dowel	
	Screws	

Accessories

Optional accessories	Description	Type
	Duct connector, Metal, L 40 mm, Tube connection 5 mm	A-22AP-A02
	Duct connector, Metal, L 100 mm, Tube connection 5 mm	A-22AP-A04
	Connection adapter, M20, for cable 1 x 6 mm, Multipack 10 pcs.	A-22G-A01.1

Wiring diagram

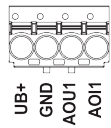
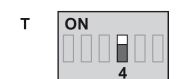
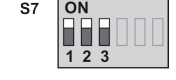
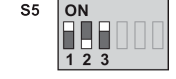
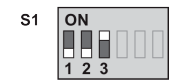
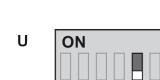
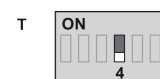
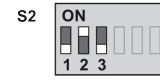
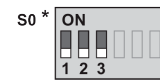
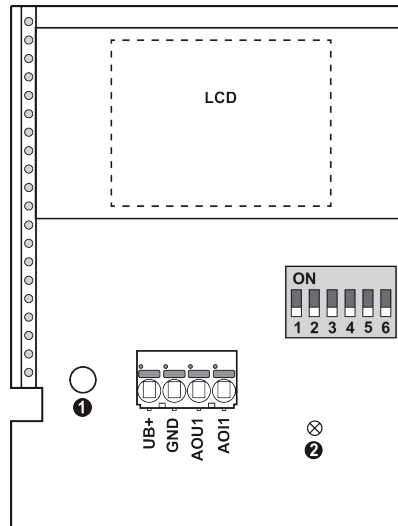

- ① Button
- ② Status LED
- * Factory setting
- P Pressure unit
- T Response time
- U Output signal

Setting	range [Pa]	range [inch WC]	Factory setting
S0	0...250	0...1	✓
S1	0...100	0...0.4	
S2	0...50	0...0.2	
S3	0...25	0...0.1	
S4	-25...25	-0.1...0.1	
S5	-50...50	-0.2...0.2	
S6	-100...100	-0.4...0.4	
S7	-150...150	-0.6...0.6	

Dimensions

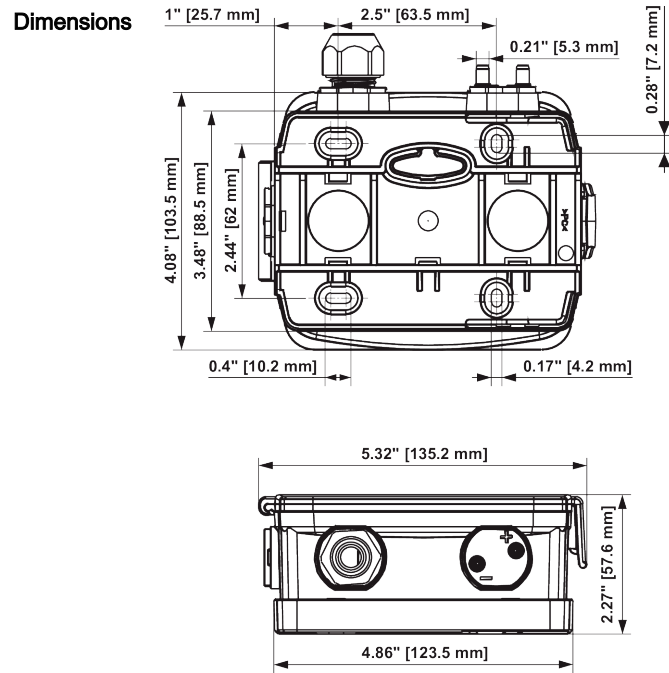

Type	Weight
22ADP-18Q	0.29 kg
22ADP-18QA	0.29 kg
22ADP-18QB	0.30 kg
22ADP-18QL	0.30 kg