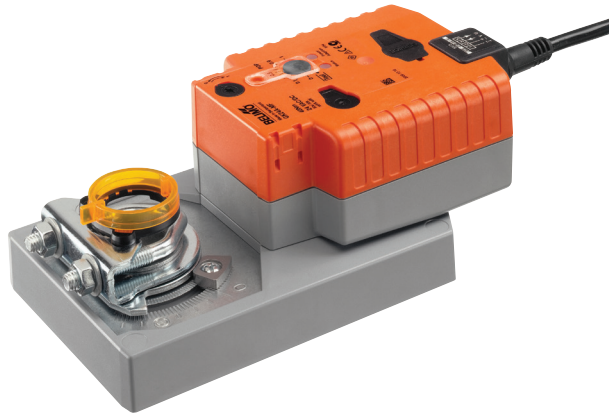

Modulating SuperCap rotary actuator with emergency control function and extended functionalities for adjusting dampers in technical building installations and in laboratories

- Air damper size up to approx. 8 m<sup>2</sup>
- Nominal torque 40 Nm
- Nominal voltage AC/DC 24 V
- Control modulating DC (0)2...10 V
- Position feedback DC 2...10 V
- Design life SuperCaps: 15 years

**Technical data**

<b>Electrical data</b>	Nominal voltage	AC/DC 24 V
	Nominal voltage frequency	50/60 Hz
	Nominal voltage range	AC 19.2...28.8 V / DC 21.6...28.8 V
	Power consumption in operation	11 W
	Power consumption in rest position	3 W
	Power consumption for wire sizing	21 VA
	Connection supply / control	Cable 1 m, 4 x 0.75 mm <sup>2</sup>
	Parallel operation	Yes (note the performance data)
<b>Functional data</b>	Torque motor	Min. 40 Nm
	Positioning signal Y	DC 0...10 V
	Positioning signal Y note	Input impedance 100 kΩ
	Operating range Y	DC 2...10 V
	Position feedback U	DC 2...10 V
	Position feedback U note	Max. 0.5 mA
	Setting emergency setting position (POP)	0...100%, adjustable in increments of 10% (POP rotary knob on 0 corresponds to left end stop)
	Bridging time (PF)	2 s
	Position accuracy	±5%
	Direction of motion motor	selectable with switch 0 / 1
	Direction of motion note	Y = 0 V: At switch position 0 (ccw rotation) / 1 (cw rotation)
	Direction of motion emergency control function	selectable with switch 0...100%
	Manual override	with push-button
	Angle of rotation	Max. 95°
	Angle of rotation note	can be limited on both sides with adjustable mechanical end stops
	Running time motor	150 s / 90°
	Running time emergency control position	35 s / 90°
	Running time emergency setting position note	<35 s @ 0...50°C
	Sound power level motor	53 dB(A)
	Sound power level emergency control position	61 dB(A)
Spindle driver	Universal spindle clamp reversible 12...26.7 mm	
Position indication	Mechanically, pluggable	
<b>Safety</b>	Protection class IEC/EN	III Safety Extra-Low Voltage (SELV)
	Protection class UL	UL Class 2 Supply
	Degree of protection IEC/EN	IP54
	Degree of protection NEMA/UL	NEMA 2, UL Enclosure Type 2
	EMC	CE according to 2014/30/EU
	Certification IEC/EN	IEC/EN 60730-1 and IEC/EN 60730-2-14
	Certification UL	cULus according to UL 60730-1A, UL 60730-2-14 and CAN/CSA E60730-1:02
	Mode of operation	Type 1..AA
	Rated impulse voltage supply / control	0.8 kV
	Control pollution degree	3
	Ambient temperature	-30...50°C

## Technical data

<b>Safety</b>	Non-operating temperature	-40...80 °C
	Ambient humidity	95% r.h., non-condensing
	Maintenance	Maintenance-free
<b>Weight</b>	Weight	2.0 kg
<b>Terms</b>	Abbreviations	POP = Power off position / emergency setting position
		PF = Power fail delay time / bridging time

## Safety notes



- The device must not be used outside the specified field of application, especially not in aircraft or in any other airborne means of transport.
- Outdoor application: only possible in case that no (sea)water, snow, ice, insolation or aggressive gases interfere directly with the actuator and that is ensured that the ambient conditions remain at any time within the thresholds according to the data sheet.
- Only authorised specialists may carry out installation. All applicable legal or institutional installation regulations must be complied during installation.
- The device may only be opened at the manufacturer's site. It does not contain any parts that can be replaced or repaired by the user.
- Cables must not be removed from the device.
- To calculate the torque required, the specifications supplied by the damper manufacturers concerning the cross-section, the design, the installation site and the ventilation conditions must be observed.
- The device contains electrical and electronic components and must not be disposed of as household refuse. All locally valid regulations and requirements must be observed.

## Product features

- Mode of operation** The actuator moves the damper to the desired operating position at the same time as the integrated capacitors are charged. Interrupting the supply voltage causes the damper to be rotated back into the emergency setting position (POP) by means of stored electrical energy.
- The actuator is connected with a standard modulating signal of DC 0...10V and drives to the position defined by the positioning signal. Measuring voltage U serves for the electrical display of the damper position 0...100% and as slave control signal for other actuators.

## Product features

**Pre-charging time (start up)** The capacitor actuators require a pre-charging time. This time is used for charging the capacitors up to a usable voltage level. This ensures that, in the event of an electricity interruption, the actuator can move at any time from its current position into the preset emergency setting position (POP). The duration of the pre-charging time depends mainly on how long the power was interrupted.

Typical pre-charging time

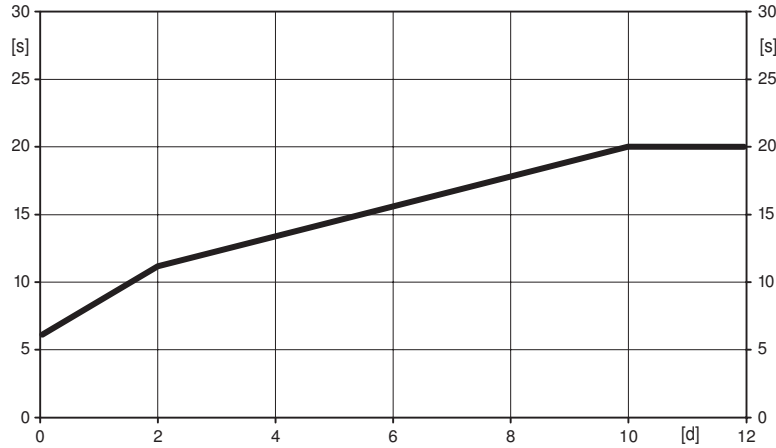

[d] = Electricity interruption in days  
[s] = Pre-charging time in seconds

**Delivery condition (capacitors)**

The actuator is completely discharged after delivery from the factory, which is why the actuator requires approximately 20 s pre-charging time before initial commissioning in order to bring the capacitors up to the required voltage level.

**Simple direct mounting**

Simple direct mounting on the damper spindle with an universal spindle clamp, supplied with an anti-rotation device to prevent the actuator from rotating.

**Manual override**

Manual control with push-button possible - temporary. The gear is disengaged and the actuator decoupled for as long as the button is pressed.

**High functional reliability**

The actuator is overload protected, requires no limit switches and automatically stops when the end stop is reached.

**Direction of rotation switch**

When actuated, the direction of rotation switch changes the running direction in normal operation. The direction of rotation switch has no influence on the emergency setting position (POP) which has been set.

**Emergency setting position (POP) rotary knob**

The rotary knob «Emergency setting position» can be used to adjust the desired emergency setting position (POP) between 0 and 100% in 10% increments. The rotary knob always refers to an angle of rotation range of 95° and does not take into account any retroactively adjusted end stops. In the event of an electricity interruption, the actuator will move into the selected emergency setting position (POP), taking into account the bridging time (PF) of 2 s which is set ex-works.

## Accessories

	Description	Type
<b>Electrical accessories</b>	Auxiliary switch, add-on, 1 x SPDT	S1A
	Auxiliary switch, add-on, 2 x SPDT	S2A
	Feedback potentiometer 140 Ohm, add-on	P140A
	Feedback potentiometer 140 Ohm, add-on, grey	P140A GR
	Feedback potentiometer 200 Ohm, add-on	P200A
	Feedback potentiometer 500 Ohm, add-on	P500A
	Feedback potentiometer 500 Ohm, add-on, grey	P500A GR
	Feedback potentiometer 1 kOhm, add-on	P1000A
	Feedback potentiometer 1 kOhm, add-on, grey	P1000A GR
	Feedback potentiometer 2.8 kOhm, add-on	P2800A

Accessories

Description	Type
Feedback potentiometer 2.8 kOhm, add-on, grey	P2800A GR
Feedback potentiometer 5 kOhm, add-on	P5000A
Feedback potentiometer 5 kOhm, add-on, grey	P5000A GR
Feedback potentiometer 10 kOhm, add-on	P10000A
Feedback potentiometer 10 kOhm, add-on, grey	P10000A GR
Adapter for auxiliary switch and feedback potentiometer	Z-SPA*
Signal converter voltage/current, supply AC/DC 24V	Z-UIC
Digital position indicator for front-panel mounting, 0...99%, front mass 72 x 72 mm	ZAD24
Range controller for wall mounting, adjustable electron. Min./max. angle of rotation limitation	SBG24
Positioner for wall mounting, range 0...100%	SGA24
Positioner in a conduit box, range 0...100%	SGE24
Positioner for front-panel mounting, range 0...100%	SGF24
Positioner for wall mounting, range 0...100%	CRP24-B1

Mechanical accessories

Description	Type
Actuator arm, for standard spindle clamp (reversible) K-SA	AH-GMA
Damper crank arm, for damper spindles	KH10
Mounting kit for linkage operation, GM..A	ZG-GMA

\* Adapter Z-SPA

It is imperative that this adapter will be ordered if an auxiliary switch or a feedback potentiometer is required and if at the same time the spindle clamp is installed on the rear side of the actuator (e.g. with short-axis installation).

Electrical installation



Notes

- Connection via safety isolating transformer.
- Parallel connection of other actuators possible. Observe the performance data.

Wiring diagrams

AC/DC 24 V, modulating

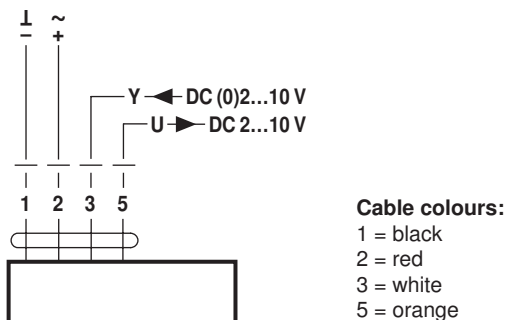

Parallel operation

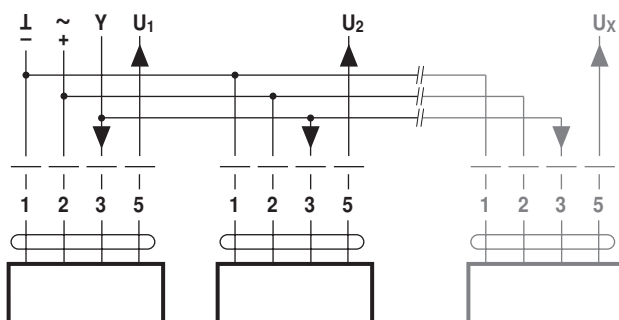

Notes

- A maximum of eight actuators can be connected in parallel.
- Parallel operation is permitted only on non-connected axes.
- Do not fail to observe performance data with parallel operation.

**Electrical installation**

Signal cable lengths

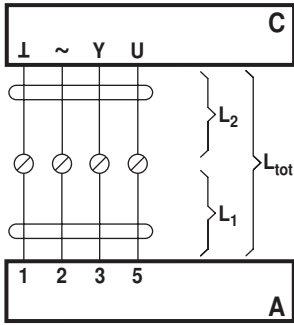

L <sub>2</sub> I / ~	L <sub>tot</sub> = L <sub>1</sub> + L <sub>2</sub>	
	AC	DC
0.75 mm <sup>2</sup>	≤30 m	≤5 m
1.00 mm <sup>2</sup>	≤40 m	≤8 m
1.50 mm <sup>2</sup>	≤70 m	≤12 m
2.50 mm <sup>2</sup>	≤100 m	≤20 m

A = actuator  
 C = control unit  
 L1 = actuator connecting cable  
 L2 = customer cable  
 Ltot = maximum signal cable length

**Note:**  
 In the event of several actuators switched in parallel, the maximum signal cable length is to be divided by the number of actuators.

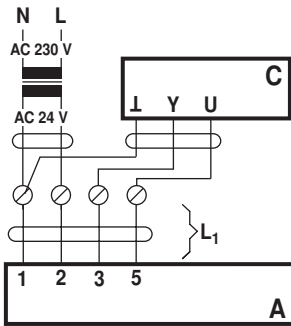

A = actuator  
 C = control unit  
 L1 = actuator connecting cable

**Note:**  
 If supply and data line are handled separately, then no special limitations apply for the installation.

Operating controls and indicators

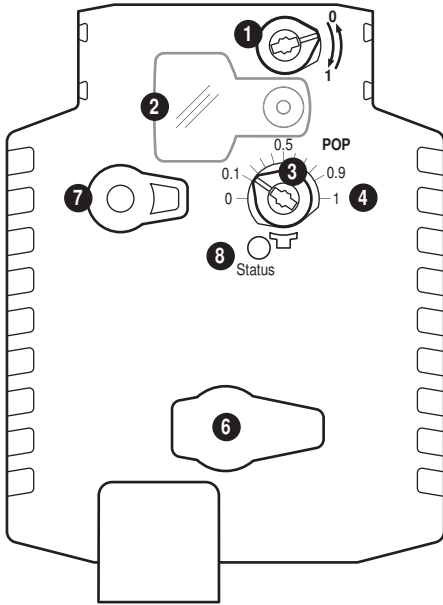

- 1 Direction of rotation switch
- 2 Cover, POP button
- 3 POP button
- 4 Scale for manual adjustment
- 6 (no function)
- 7 Disengagement button

LED display	Meaning / function
8 green	
On	Operation OK / without fault
Flashing	POP function active
Off	– Not in operation – Pre-charging time SuperCap – Fault SuperCap

Setting emergency setting position (POP)

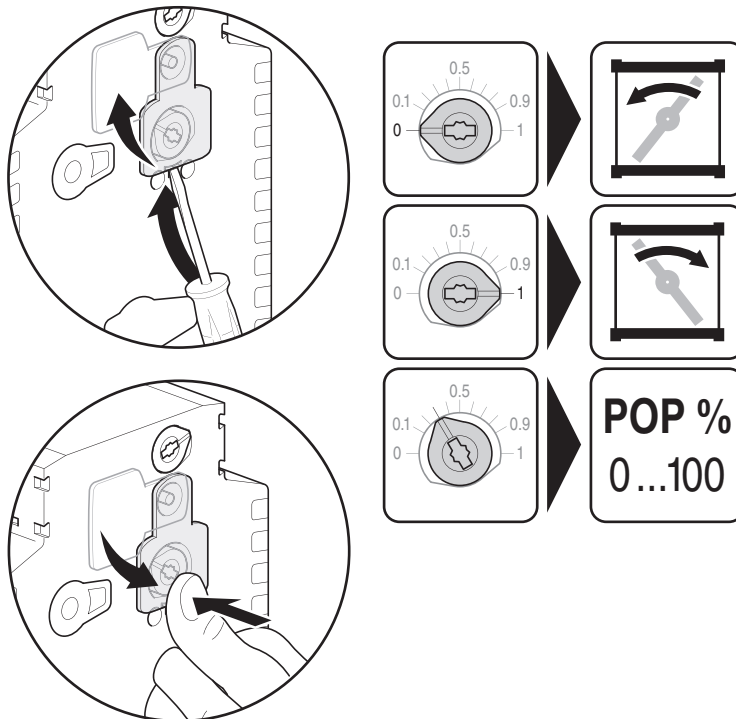

Dimensions [mm]

Spindle length

	Min. 52
	Min. 20

Clamping range

	12...22	12...18
	22...26.7	12...18

\*Option: Spindle clamp mounted below: When an auxiliary switch or a feedback potentiometer is used the adapter Z-SPA is required.

Dimensional drawings

