

Configurable damper actuator for adjusting dampers in technical building installations

- Air damper size up to approx. 4 m²
- Torque motor 20 Nm
- Nominal voltage AC/DC 24 V
- Control modulating 0...20 V PhC
- Position feedback 2...10 V

Technical data

Electrical data	Nominal voltage	AC/DC 24 V
	Nominal voltage frequency	50/60 Hz
	Nominal voltage range	AC 19.2...28.8 V / DC 21.6...28.8 V
	Power consumption in operation	3.5 W
	Power consumption in rest position	1.25 W
	Power consumption for wire sizing	6 VA
	Connection supply / control	Cable 1 m, 4 x 0.75 mm ²
	Parallel operation	Yes (note the performance data)
Functional data	Torque motor	20 Nm
	Torque variable	25%, 50%, 75% reduced
	Operating range Y	0...20 V PhC
	Input Impedance	8.2 kΩ
	Position feedback U	2...10 V
	Position feedback U note	Max. 0.5 mA
	Position feedback U variable	Start point 0.5...8 V End point 2.5...10 V
	Position accuracy	±5%
	Direction of motion motor	selectable with switch 0/1
	Direction of motion note	Y = 0 V: At switch position 0 (ccw rotation) / 1 (cw rotation)
	Direction of motion variable	electronically reversible
	Manual override	with push-button, can be locked
	Angle of rotation	Max. 95°
	Angle of rotation note	can be limited on both sides with adjustable mechanical end stops
	Running time motor	150 s / 90°
	Running time motor variable	90...350 s
	Adaptation setting range	manual
	Adaptation setting range variable	No action Adaptation when switched on Adaptation after pushing the gear disengagement button
	Override control	MAX (maximum position) = 100% MIN (minimum position) = 0%
	Override control variable	MAX = (MIN + 32%)...100% MIN = 0%...(MAX - 32%)
Sound power level, motor	45 dB(A)	
Mechanical interface	Universal shaft clamp reversible 10...20 mm	
Position indication	Mechanically, pluggable	
Safety	Protection class IEC/EN	III Safety Extra-Low Voltage (SELV)
	Protection class UL	UL Class 2 Supply
	Degree of protection IEC/EN	IP54
	Degree of protection NEMA/UL	NEMA 2
	Enclosure	UL Enclosure Type 2
	EMC	CE according to 2014/30/EU
	Certification IEC/EN	IEC/EN 60730-1 and IEC/EN 60730-2-14
Certification UL	cULus according to UL60730-1A, UL60730-2-14 and CAN/CSA E60730-1:02	

Technical data

Safety	Certification UL note	The UL marking on the actuator depends on the production site, the device is UL-compliant in any case
	Mode of operation	Type 1
	Rated impulse voltage supply / control	0.8 kV
	Control pollution degree	3
	Ambient temperature	-30...50°C
	Storage temperature	-40...80°C
	Ambient humidity	Max. 95% r.H., non-condensing
	Servicing	maintenance-free
Weight	Weight	1.9 kg

Safety notes



- The device must not be used outside the specified field of application, especially not in aircraft or in any other airborne means of transport.
- Outdoor application: only possible in case that no (sea) water, snow, ice, insolation or aggressive gases interfere directly with the actuator and that is ensured that the ambient conditions remain at any time within the thresholds according to the data sheet.
- Only authorised specialists may carry out installation. All applicable legal or institutional installation regulations must be complied during installation.
- The device may only be opened at the manufacturer's site. It does not contain any parts that can be replaced or repaired by the user.
- Cables must not be removed from the device.
- To calculate the torque required, the specifications supplied by the damper manufacturers concerning the cross-section, the design, the installation site and the ventilation conditions must be observed.
- The device contains electrical and electronic components and must not be disposed of as household refuse. All locally valid regulations and requirements must be observed.

Product features

Mode of operation	The actuator is connected with a standard modulating signal of 0...20 V phase-cut signal and drives to the position defined by the positioning signal. Measuring voltage U serves for the electrical display of the damper position 0...100% and as slave control signal for other actuators.
Parametrisable actuators	The factory settings cover the most common applications. Single parameters can be modified with the Belimo Service Tools MFT-P or ZTH EU.
Simple direct mounting	Simple direct mounting on the damper shaft with a universal shaft clamp, supplied with an anti-rotation device to prevent the actuator from rotating.
Manual override	Manual override with push-button possible (the gear is disengaged for as long as the button is pressed or remains locked).
Adjustable angle of rotation	Adjustable angle of rotation with mechanical end stops.
High functional reliability	The actuator is overload protected, requires no limit switches and automatically stops when the end stop is reached.
Home position	The first time the supply voltage is switched on, i.e. at the time of commissioning, the actuator carries out a synchronisation. The synchronisation is in the home position (0%). The actuator then moves into the position defined by the positioning signal.

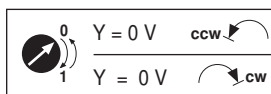

Product features

- Adaption and synchronisation** An adaption can be triggered manually by pressing the “Adaption” button or with the PC-Tool. Both mechanical end stops are detected during the adaption (entire setting range).
Automatic synchronisation after pressing the gearbox disengagement button is configured. The synchronisation is in the home position (0%).
The actuator then moves into the position defined by the positioning signal.
A range of settings can be adapted using the PC-Tool (see MFT-P documentation)

Accessories

	Description	Type
Electrical accessories	Auxiliary switch 1 x SPDT add-on	S1A
	Auxiliary switch 2 x SPDT add-on	S2A
	Auxiliary switch 2 x SPDT add-on, grau	S2A/300 GR
	Auxiliary switch 2 x SPDT add-on, grau	S2A/500 GR
	Feedback potentiometer 200 Ω add-on	P200A
	Feedback potentiometer 500 Ω add-on	P500A
	Feedback potentiometer 500 Ω add-on, grau	P500A GR
	Feedback potentiometer 1 kΩ add-on	P1000A
	Feedback potentiometer 2.8 kΩ add-on	P2800A
	Feedback potentiometer 2.8 kΩ add-on, grau	P2800A GR
	Feedback potentiometer 1 kΩ add-on, grau	P1000A GR
	Feedback potentiometer 5 kΩ add-on	P5000A
	Feedback potentiometer 5 kΩ add-on, grau	P5000A GR
	Feedback potentiometer 10 kΩ add-on	P10000A
	Feedback potentiometer 10 kΩ add-on, grau	P10000A GR
	Signal converter voltage/current 100 kΩ Supply AC/DC 24 V	Z-UIC
	Range controller for wall mounting	SBG24
	Positioner for wall mounting	SGA24
	Positioner for built-in mounting	SGE24
	Positioner for front-panel mounting	SGF24
Positioner for wall mounting	CRP24-B1	
Connection cable 5 m, A: RJ11 6/4 ZTH EU, B: 6-pin service socket for Belimo device	ZK1-GEN	
Connection cable 5 m, A: RJ11 6/4 ZTH EU, B: free wire end for connection to MP/PP terminal	ZK2-GEN	
Mechanical accessories	Description	Type
	Actuator arm for standard shaft clamp (reversible)	AH-20
	Shaft extension 240 mm Ø20 mm for damper shaft Ø 12...21 mm CrNi	AV12-25-I
	Shaft extension 240 mm Ø20 mm for damper shaft Ø 8...22.7 mm	AV8-25
	Ball joint suitable for damper crank arm KH8	KG8
	Ball joint suitable for damper crank arm KH8 / KH10	KG10A
	Damper crank arm Slot width 8.2 mm, clamping range Ø10...18 mm	KH8
	Shaft clamp one-sided, clamping range Ø8...26 mm, Multipack 20 pcs.	K-ENSA
	Shaft clamp one-sided, clamping range Ø12...26 mm, for CrNi shaft (INOX), Multipack 20 pcs.	K-ENSA-I
	Shaft clamp reversible, clamping range Ø10...20 mm	K-SA
	Anti-rotation mechanism 180 mm, Multipack 20 pcs.	Z-ARS180
	Anti-rotation mechanism 230 mm, Multipack 20 pcs.	Z-ARS230
	Form fit insert 10x10 mm, Multipack 20 pcs.	ZF10-NSA
	Form fit insert 12x12 mm, Multipack 20 pcs.	ZF12-NSA
	Form fit insert 15x15 mm, Multipack 20 pcs.	ZF15-NSA
	Form fit insert 16x16 mm, Multipack 20 pcs.	ZF16-NSA
	Mounting kit for linkage operation for flat installation	ZG-SMA
	Position indicator, Multipack 20 pcs.	Z-PI
	Base plate extension for SM..A to SM../AM../SMD24R, Multipack 20 pcs.	Z-SMA

Accessories

Service Tools	Description	Type
	Service Tool, with ZIP-USB function	ZTH EU
	Adapter for Service-Tool ZTH	MFT-C
	Belimo PC-Tool, Software for adjustments and diagnostics	MFT-P

Electrical installation

Notes

- Connection via safety isolating transformer.
- Parallel connection of other actuators possible. Observe the performance data.

Wiring diagrams

AC/DC 24 V, modulating

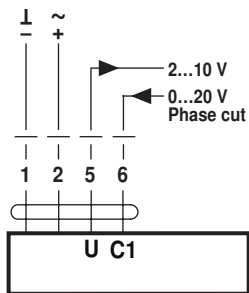

Cable colours:
 1 = black
 2 = red
 5 = orange
 6 = pink

Functions

Functions with basic values (conventional mode)

Override control with AC 24 V with relay contacts

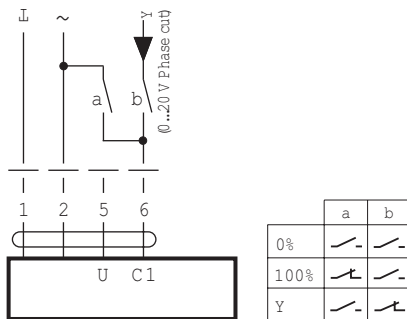

Override control with AC 24 V with rotary control switch

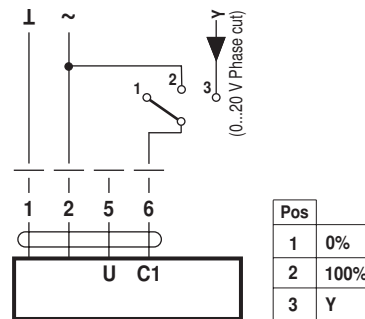

Master/Slave control

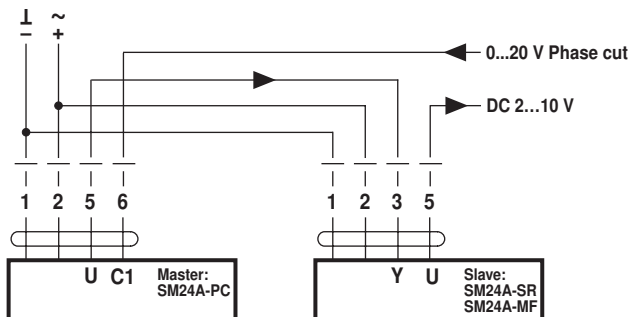

Operating controls and indicators

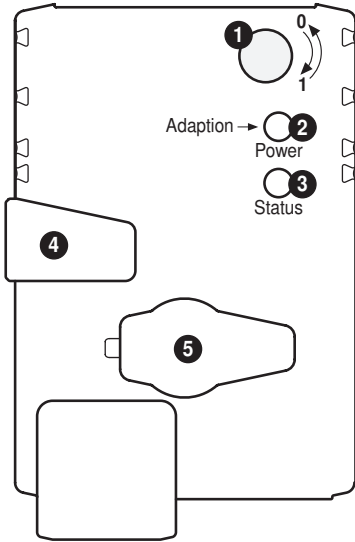

- 1 Direction of rotation switch**
Switch over: Direction of rotation changes
- 2 Push-button and LED display green**
Off: No power supply or malfunction
On: In operation
Press button: Triggers angle of rotation adaptation, followed by standard mode
- 3 Push-button and LED display yellow**
Off: Standard mode
On: Adaptation or synchronising process active
Press button: No function
- 4 Gear disengagement button**
Press button: Gear disengages, motor stops, manual override possible
Release button: Gear engages, synchronisation starts, followed by standard mode
- 5 Service plug**
For connecting parameterisation and service tools

Check power supply connection

- 2** Off and **3** On Possible wiring error in power supply

Service

Service Tools connection The actuator can be configured by PC-Tool and ZTH EU via the service socket.
Connection ZTH EU / PC-Tool

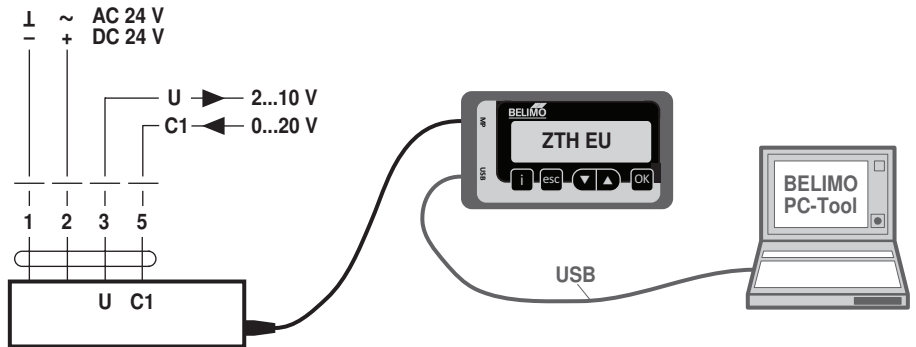

Dimensions [mm]

Spindle length

	Min. 48
	Min. 20

Clamping range

	10...20	≥10	≤20
CrNi (INOX)	12...20	≥10	≤20

When using a round spindle made of CrNi (INOX): Ø 12...20 mm

Dimensional drawings

